

# 23204

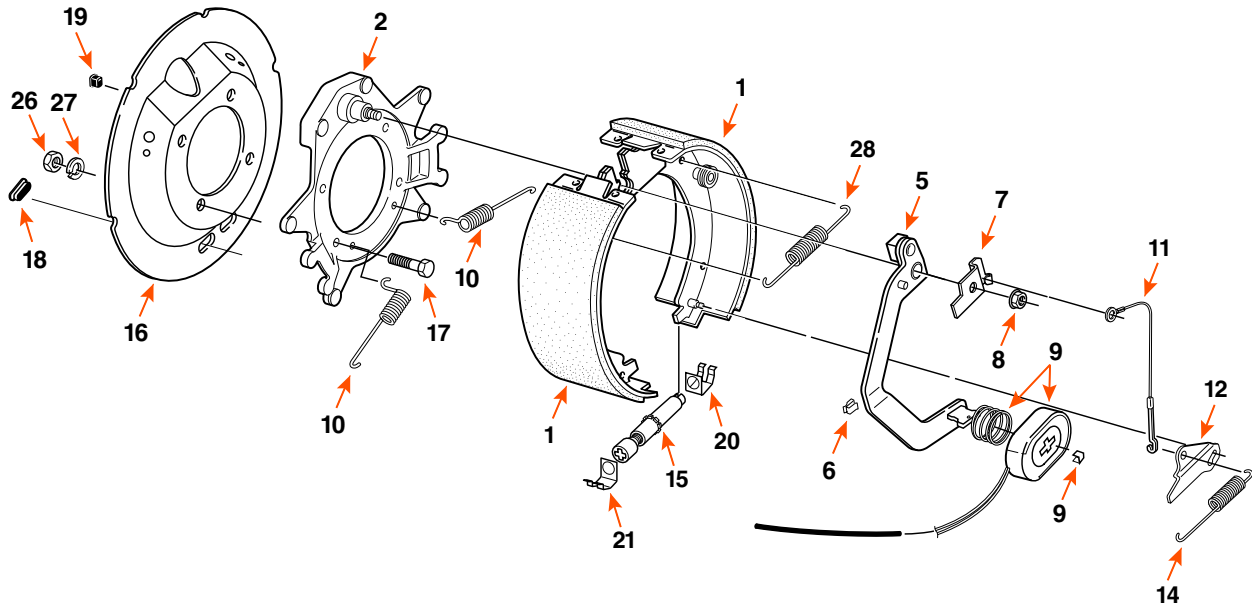

## FREIN ÉLECTRIQUE / ELECTRIC BRAKE



DIMENSION	CAPACITÉ CAPACITY	CÔTÉ SIDE	MARQUE BRAND
-----------	----------------------	--------------	-----------------

12<sup>1/4</sup>" X 5"

15K

DROIT / RIGHT



COMPOSANTE COMPONENT	DESCRIPTION	QUANTITÉ QUANTITY	DEXTER	FRAMECO
1	BANDE DE FREIN / BRAKE SHOE KIT	1	71502	71502X
5	LEVIER ACTIF / ACTUATING LEVER ARM	1	4712335	-
6	SUPPORT DE FIL / WIRE CLIP	3	2739	-
7	SUPPORT DE LEVIER / ARM SHOE RETAINER	1	714552	-
8	ÉCROU 3/8" FLANGE NUT	1	662	-
9	AIMANT / MAGNET KIT	1	71109	71108X / 71109X
9	RESSORT D'AIMANT / MAGNET SPRING	1	46117	-
9	BARRURE D'AIMANT / MAGNET RETAINER CLIP	1	4655	-
10	RESSORT DE CENTRAGE / SHOE CENTERING SPRING	2	46136	-
11	CÂBLE D'AJUSTEMENT / ADJUSTER CABLE	1	71462	-
12	LEVIER D'AJUSTEMENT / SELF-ADJUSTING LEVER	1	71463	-
14	RESSORT D'AJUSTEMENT / ADJUSTING SCREW SPRING	1	46137	-
15	VIS D'AJUSTEMENT / ADJUSTING SCREW	1	4820	-
16	PLAQUE ANTI-POUSSIÈRE / BRAKE DUST SHIELD	1	36115	36115X
17	BOULON 7/16"-20 X 1 3/4" BOLT	6	6017	-
19	PROTECTEUR DE FIL / WIRE GROMMET	1	46016	-
20	CLIP D'AJUSTEMENT (CÔTÉ BARIL) / ADJUSTER CLIP (BARREL END)	1	46133	-
21	CLIP D'AJUSTEMENT (CÔTÉ FILET) / ADJUSTER CLIP (THREAD END)	1	46132	-
26	ÉCROU 7/16"-20 NUT	6	-	6018
27	RONDELLE À RESSORT 7/16" SPLIT LOCK WASHER	6	-	6019
28	RESSORT DE RETOUR / RETRACTOR SPRING	1	46119	-